

## Basic 2 shelving system

Basic 2 is a flexible and functional shop fitting system. The system is easy to handle, has loose feet, can be supplied with different back panel solutions and consist of basic modules in 60 or 90 cm for wall or floor as well as wall uprights for presentation of lightweight items. The numerous possibilities of combination make the system to fit virtually all sectors. Basic 2 is made of steel that is a eco-friendly material.

The Basic 2 system offers numerous possibilities of combination and can be build single-sided or double-sided units that stand on their own feet or can be wall-mounted without legs and backgrounds.

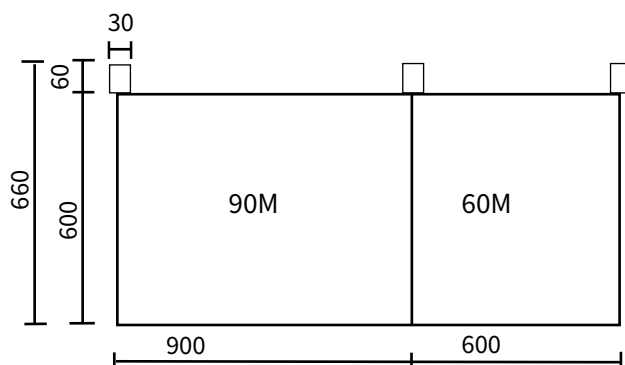

height	depth	width
1420 mm	300 mm	600 mm
1580 mm	400 mm	900 mm
1880 mm	500 mm	
2120 mm	600 mm	
2280 mm		
2990 mm		



### Product info

- uprights, feet, shelves and brackets are powder coated steel
- wire shelves are galvanized steel
- colours: grey RAL 7045, other RAL -shades by order
- shelf adjustment range 32 mm
- carrying capacity 195-645 kg/shelf
- accessories: dividers, back panel with holes, hook and price rails

### Manufacture and sale

#### Denmark

Expedit A/S  
Toftegaardsvej 4, 8370 Hadsten  
T: +45 87 612 200  
expedit@expedit.dk, www.expedit.dk

#### Sweden

Expedit AB  
Dammvägen 1, S-571 75 Fredriksdal  
T: +46 10 47 61 700  
office@expedit.se, www.expedit.se

#### Norway

Expedit Norge AS  
Thorøyaveien 21, N-3209 Sandefjord  
T: +47 33 42 32 80  
post@expedit.no, www.expedit.no