

Transport made easy

Decide on a Wanzl trolley

YOUR BENEFITS AT A GLANCE:

- Protection of the interior thanks to deflectors
- Sturdy metal construction
- Trolleys are highly agile and manoeuvrable

Highlights **_MADE BY WANZL**

Innovative products from a single source



IN-HOUSE CASTOR PRODUCTION



IN-HOUSE CAD DEVELOPMENT

Production

■ **Wanzl sets the standards for production:** in all production processes, Wanzl's quality policy results in products guaranteed to be made from the best materials, with first-class workmanship and well-finished surfaces. This ensures long-term maintenance-free use and that every investment retains its value.

Quality

■ **Wanzl sets the standards for quality:** particularly with regards to smooth running. The maintenance-free castors are mounted on two ball bearings, have abrasion-proof treads and feature steering forks with ball bearings. As a result, our chambermaid trolleys are quiet, smooth-running and easy to steer.

Innovation

■ **Wanzl sets the standards for innovation:** from practical experience – for practical use. Using cutting-edge production and design technology, we create innovative, forward-looking products and constantly set new standards for handling and effectiveness.

Update your housekeeping

As individual as your guests



OUR EXPERTS TAKE THE TIME THAT THEY NEED

■ Our services:

- Personal consultation with our team of experts
- Easy to reorder spare parts
- 36 months' warranty on Wanzl castors
- 10-year availability guarantee
- Extensive service partner network
- Made in Germany

What is important to you?

*Stability – durability – design –
customisation – robustness – price –
size – flexibility*

■ Benefit from our experience and provide your housekeeping with the best equipment.

Our products are designed for hotel-specific challenges and conditions and provide your staff with optimal support. Especially with our chambermaid trolleys, we always have a suitable trolley for the varied requirements of the establishment. Whether standard, flexible or customised chambermaid trolley – working efficiently is not a question of price. Let us help you find your favourite products. Tell us about your needs, problems and challenges and together we will find a suitable product for you.

Tantum 9 chambermaid trolleys

Robust space saver at a low price

STANDARD



TANTUM 9

Frame in metallic black
Illustration shows optional equipment

■ In an international comparison, the Tantum 9 chambermaid trolley is the most economical. The model impresses with its lack of plastic parts. It is therefore more robust and hygienic. Its rear panel is made of hard-wearing, impact-resistant wood. It also serves as a privacy and dirt screen and, like the side panels and wire shelves, can be retrofitted if required. This means that its durability makes it so economical.

Tantum 9	Order no.
Dimensions	853 x 505 x 1231
Plastic powder coating, black metallic	04.15708.95-7097

ZP Classic chambermaid trolley

Perfect housekeeping

FLEXIBLE



ZP-7 CLASSIC

Anthracite finish
Illustration shows optional equipment

■ The tried-and-tested design from Wanzl.

The special features of the Classic Chambermaid trolley help the room service personnel to provide a perfect service. It can be customised as required by adding practical accessories.

Finishes



Design pend.

Models	ZP-7	ZP-9	ZP-11
Dimensions	805 x 555 x 1300	965 x 555 x 1300	1155 x 555 x 1300
ZP Premium Classic	Order no.	Order no.	Order no.
Anthracite, natural oak, mahogany finish	04.01244.95-V	04.01245.95-V	04.01246.95-V

ZP-Eco chambermaid trolley

Housekeeping meets environmental protection

FLEXIBLE



ZP-11 ECO
Mahogany finish
Illustration shows optional equipment

■ **The environmentally friendly design from Wanzl.** The special features of the Eco chambermaid trolley are particularly helpful for separating waste and can be upgraded with practical accessories.

Finishes



Design pend.

Models	ZP-7	ZP-9	ZP-11
Dimensions	805 x 555 x 1300	965 x 555 x 1300	1155 x 555 x 1300
ZP Premium Eco	Order no.	Order no.	Order no.
Anthracite, natural oak, mahogany finish	04.01247.95-V	04.01248.95-V	04.01249.95-V

ZP-Clean chambermaid trolley

Ultra-hygienic housekeeping

FLEXIBLE



ZP-9 CLEAN
Natural oak finish
Illustration shows optional equipment

■ **The cleaning specialist from Wanzl.** The special features of the Clean chambermaid trolley help make cleaning more efficient. Like all ZP models, it can be upgraded with practical accessories.

Finishes



Design pend.

Models	ZP-7	ZP-9	ZP-11
Dimensions	805 x 555 x 1300	965 x 555 x 1300	1155 x 555 x 1300
ZP Premium Clean	Order no.	Order no.	Order no.
Anthracite, natural oak, mahogany finish	04.01257.95-V	04.01258.95-V	04.01259.95-V

ZP standard equipment and accessories

Choose the items that will match your décor from our extensive range of accessories

Top box

Everything is safe: valuables can be transported safely in the lockable top box.



Small items box

For even better organisation: clear arrangement of guest supplies. Wooden box for small items – with clear varnish, painted in light pearl grey or black.

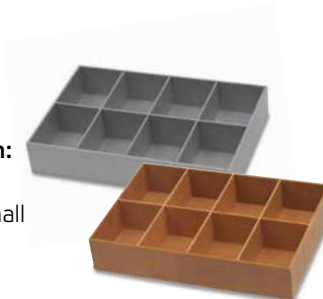

SmartFix mobile phone holder

A lockable smartphone holder with universal mounting system. The smartphone is locked by means of a two-digit combination lock.



Holder for sanitiser dispenser

The holder is easy to install and serves as a holder for all standard sanitiser dispensers.



Equipment pocket

Accessories for even more space: for transporting additional equipment.



Flexible mop holder

Bulky cleaning equipment is therefore stored safely and securely.



Accessories	ZP-7 Order no.	ZP-9 Order no.	ZP-11 Order no.
Top box, metal, plastic powder-coated in titanium grey	04.03504.73-7084	04.03504.73-7084	04.03504.73-7084
Wooden box for small items, painted light pearl grey	00.21837.78-9022	00.21837.78-9022	00.21837.78-9022
Wooden box for small items, clear varnished	00.60694.78-0000	00.60694.78-0000	00.60694.78-0000
SmartFix mobile phone holder	77.68442.76-7084	77.68442.76-7084	77.68442.76-7084
Sanitiser holder	77.62325.95-7084	77.62325.95-7084	77.62325.95-7084
Equipment pocket, polyester, grey	00.22515.00-0000	00.22515.00-0000	00.22515.00-0000
Mop holder (for self-installation)	04.08815.95-0000	04.08815.95-0000	04.08815.95-0000

X-Bed additional bed

An extra bed for use anywhere

■ **The X-Bed provides pleasant resting comfort** and has a seat height of approx. 55 cm. The grid support allows for perfect ventilation of the mattress.

120 kg ↓

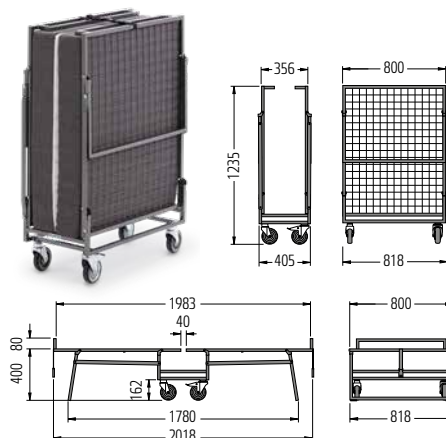

X-BED
Illustration shows optional equipment

X-Bed	Order no.
Plastic powder coating, black metallic	04.15256.73-7097
Accessories	
Polyether foam mattress, 80 x 200 x 15 cm	04.15482.07-0000

RSVC Comfort room service table

The room service table

■ **Ideally dimensioned and stable side table** for hotel rooms and restaurants, folding sides for narrow passages. Also available on request with integrated hot box for keeping meals hot.

RSVC COMFORT
Room service table

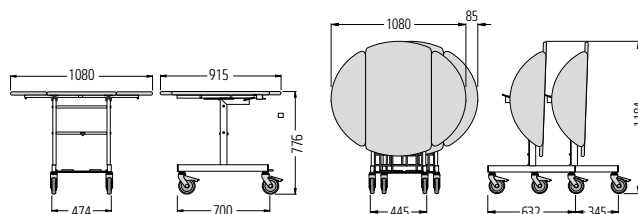

Can be nested to save space



RSVC COMFORT
folded



RSVC COMFORT
with hot box

RSVC Comfort room service table	Order no.
With fold-down side sections and two rack shelves	04.12883.95-0000
Accessories	
Removable handle	04.12996.73-9005
Dimensions for 1 hot box (mm) W 410 x D 410 x H 530	
Electric hot box, with 3 shelves, stainless steel	77.91379.09-0000
Electric hot box, with 3 shelves, black	77.91379.09-0001
Shelf unit for 6 hot boxes, mobile	
Dimensions (mm) W 1050 x D 500 x H 1500	04.14804.73-7084

Handcart SW 145 KX

Agile model for hotels of every size

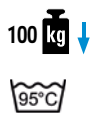

SW 145 KX
With polyester bag and
hook and loop fastener



SW 145 KX
Can be folded to save
space

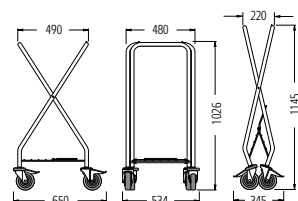

■ **A flexible laundry trolley for all situations.** A practical handcart, including a strong polyester bag. The SW 145 KX can also be equipped with a plastic bag to transport rubbish.

Handcart SW 145 KX	Order no.
Basic frame with polyester bag and hook and loop fastener	04.03843.95-7097
Basic frame with plastic bag and holder	04.03618.95-7097
Accessories	
Holder for plastic bag, incl. fixing material	04.03956.52-0000
Bags for reordering	
1 polyester bag, 145 litres, grey	77.94057.00-0000
1 pack of plastic bags, 120 litres, grey (1 pack = 25 units)	00.24436.00-0000

Handcart SW 290 KX

Agile model for hotels of every size



SW 290 KX
With polyester bag and
hook and loop fastener



SW 290 KX
Can be folded to save
space

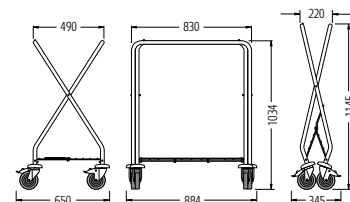

■ **A flexible laundry trolley for all situations.** A practical handcart, including a strong polyester bag to, for example, transport laundry.

Handcart SW 290 KX	Order no.
Basic frame with polyester bag and hook and loop fastener	04.15934.95-7097
Accessories	
Bags for reordering	
1 polyester bag, 290 litres, grey	77.95527.00-0000

Handcart LT 240

XXL laundry service

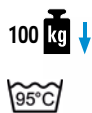

LT 240
Handcart



LT 240
Practical hook and loop fastener

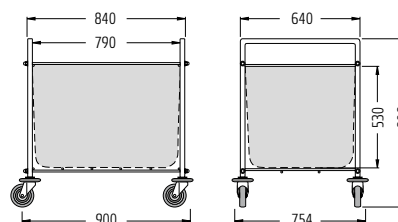

■ The XXL model with a volume that saves personnel unnecessary trips. Maximum benefit and simple handling make the LT 240 an essential and functional assistant for hectic every-day hotel work.

Handcart LT 240	Order no.
With 1 polyester bag, grey, as standard	04.13900.95-7097
For reordering	
Polyester bag, grey, 240 litres	00.58562.00-0000
Polyester bag, grey, 240 litres, with cover	00.58563.00-0000

Shelved laundry trolley KT3

Transport trolley for clean laundry



SHELVED LAUNDRY TROLLEY KT3
Illustration shows optional equipment



SHELVED LAUNDRY TROLLEY KT3
Illustration shows optional equipment

■ The trolley impresses with flexible shelves and is highly agile thanks to its 5th castor. Comes with two push handles as standard.

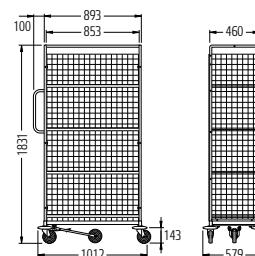

Shelved laundry trolley KT3	Order no.
High gloss, galvanised, chrome plated	06.00231.50-V310

GS-Lobby luggage collection trolley

The elegant luggage collection trolley

200 kg ↓



GS-LOBBY
Stainless steel, electro-polished, with parking brake

Carpet finishes



GS-LOBBY
Stainless steel, gold-plated

■ **For arriving guests**, the luggage collection trolley contributes to the first impression. This elegant design with high-grade surfaces and appealing, colourful carpet inlays will live up to the hotel's image.

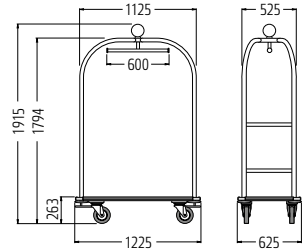

GS-Lobby luggage collection trolley	Order no.
Electro-polished stainless steel, carpet in anthracite	04.14691.31-0000
Gold-plated stainless steel, carpet in red	04.14691.58-0001
Electro-polished stainless steel, carpet in anthracite, with parking brake	04.14691.31-0001
Gold-plated stainless steel, carpet in red, with parking brake	04.14691.58-0000
Logo carpet (from 3 units)	On request

Premium GS-Trend luggage collection trolley

The extravagant luggage collection trolley

200 kg ↓



GS-TREND
Electro-polished stainless steel
Illustration shows optional equipment.

Carpet finishes



GS-TREND
Electro-polished stainless steel
Illustration shows optional equipment.

■ **Elegant and stylish** first impression. Innovation and quality packaged in an elegant design: the GS-Trend.

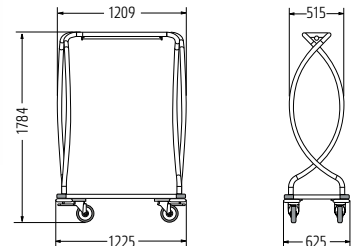

GS-Trend luggage collection trolley	Order no.
Electro-polished stainless steel, carpet in anthracite	05.59778.31-V006
Electro-polished stainless steel, carpet in anthracite, with parking brake	05.59778.31-V007
Logo carpet (from 3 units)	On request

Travel 300 luggage transport trolley

Luggage transport trolley – simple and convenient



TRAVEL 300
Luggage transport trolley

■ The tried-and-tested **design with** stable luggage area, an effective brake mechanism with a self-adjusting, maintenance-free brake and exemplary reliability make the Travel 300 a popular choice worldwide for transporting luggage.

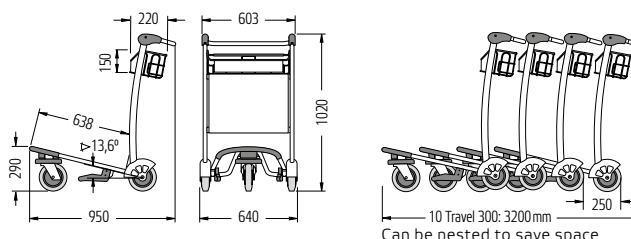

Travel 300 luggage transport trolley	Order no.
Galvanised chrome-plated steel, with brake	05.44296.52-V008

Pat. pend.

Aera 300 L luggage transport trolley

The elegant luggage transport trolley



AERA 300 L
Luggage transport trolley

■ In a **slim design with a clear geometry** and elegantly curved lines: the Aera 300 L not only looks good, but is also sure to impress with its manoeuvrability and practical detailed solutions.

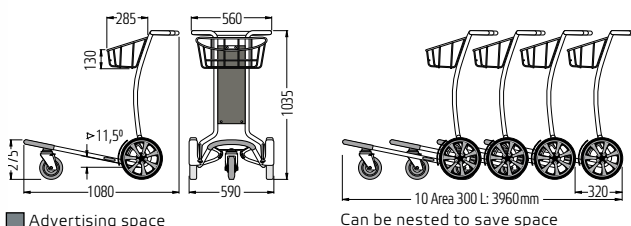

■ Advertising space	
Aera 300 L luggage transport trolley	Order no.
Galvanised chrome-plated	05.60795.52-0000

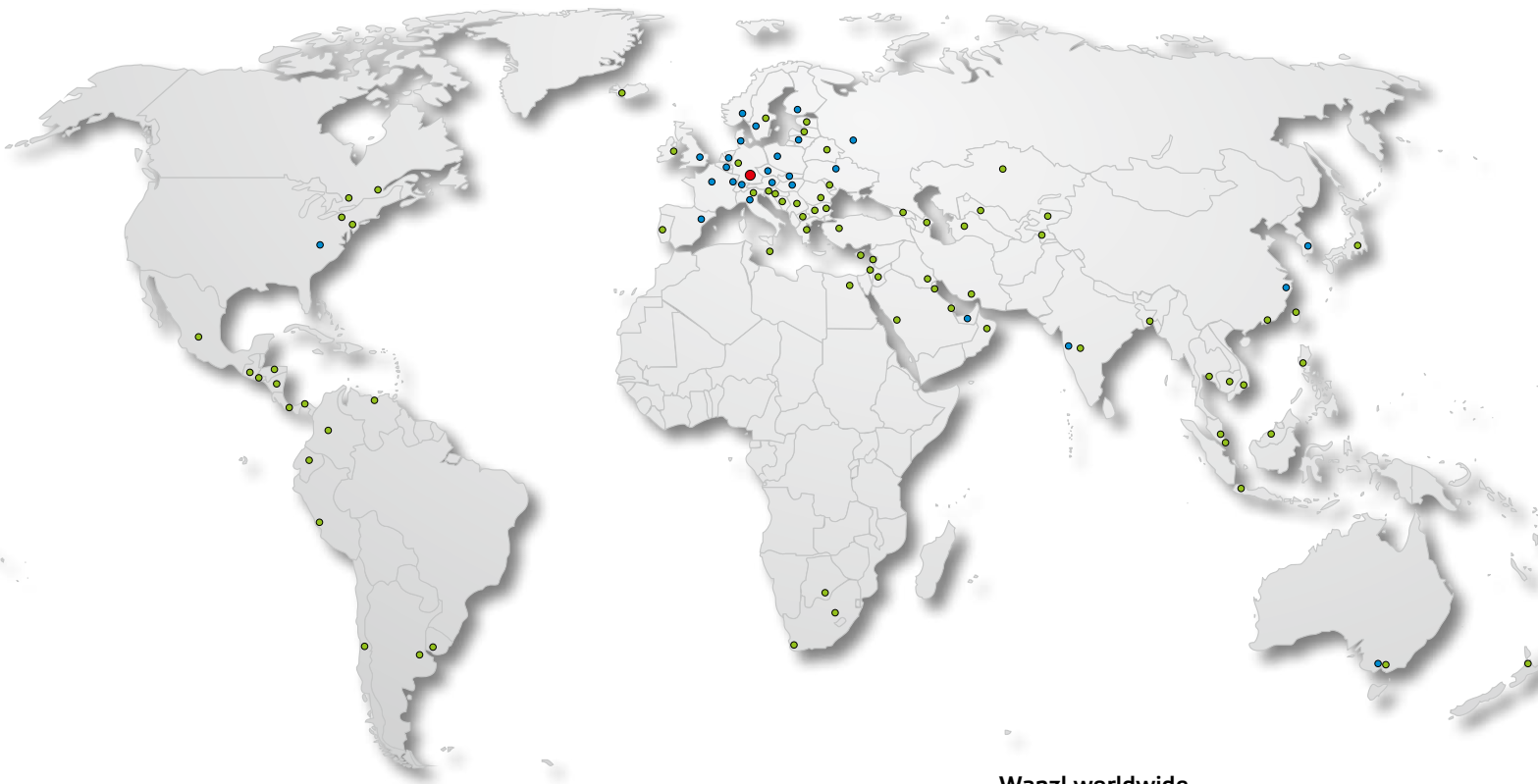

Wanzl worldwide

- Head Office
- Subsidiaries
- Partners



GERMANY
Wanzl GmbH & Co. KGaA
Rudolf-Wanzl-Straße 4
89340 Leipheim

Phone +49 (0) 82 21 / 7 29-0
Fax +49 (0) 82 21 / 7 29-6530

hotel@wanzl.com
www.wanzl.com